

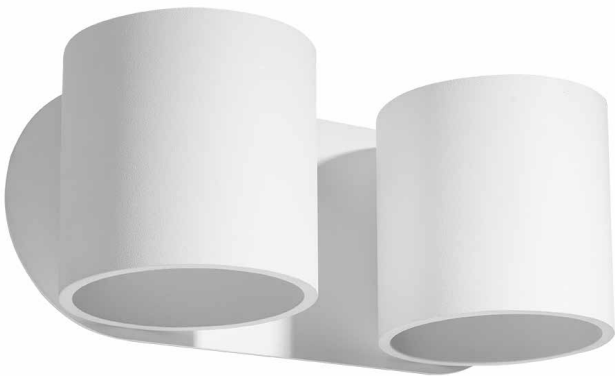







KINKIET / WALL LAMP / WANDLEUCHTE

# ORBIS 2

biały / white / weiß



-  G9, 2 x 40 W, 2 x 12 W LED \*
-  ~ 220-230 V, 50-60 Hz
-  26 x 12 x 10 cm
-  aluminium / aluminium / Aluminium
-  biały / white / weiß
-  31 x 14 x 14 cm
-  netto: 1,4 kg, brutto: 1,55 kg  
/ net: 1,4 kg, gross: 1,55 kg  
/ netz: 1,4 kg, brutto: 1,55 kg

 IP20

SL.0659

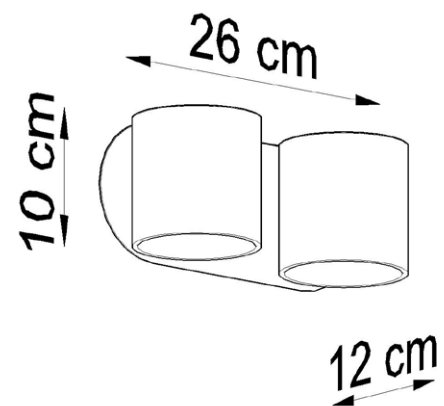

Podzespoły zastosowane w oprawach:

- oprawka G9, 2 A, 250 V
- przewód przyłączeniowy 0,75 mm<sup>2</sup>
- złączki zaciskowe

/ Components used in luminaries:

- holder G9, 2 A, 250 V
- connection cable 0,75 mm<sup>2</sup>
- compression fittings

/ Bauelemente der Fassungen:

- fassung G9, 2 A, 250 V
- elektrische Leitung 0,75 mm<sup>2</sup>
- Klemmen

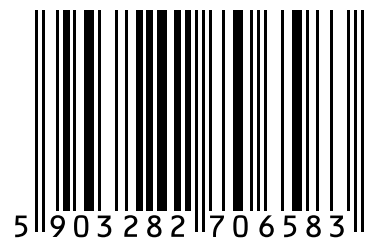

\* Źródło światła nie jest w komplecie / Light bulb not included / Leuchtmittel nicht inkl.



Made in EU